







**SYMETRICS Concealed two-way diverter - Chrome**

IMO

36 200 985

- rotary diverter
- rosette 60 x 60 mm



	Chrome	36 200 985-00
	Brushed Platinum	36 200 985-06
	Brushed Light Gold	36 200 985-27
	Brushed Durabrass (23kt Gold)	36 200 985-28
	Brushed Champagne (22kt Gold)	36 200 985-46
	Champagne (22kt Gold)	36 200 985-47
	Brushed Dark Platinum	36 200 985-99

**Required miscellaneous**



- Concealed two-way diverter -** 35 202 970 90
- max. recess depth 160 mm
  - min. recess depth 85 mm

36 200 985

mm [inches]

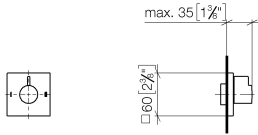

### Flow rate chart



### Certificates

LGA\_38379.

WRAS\_2307045.

36 200 985

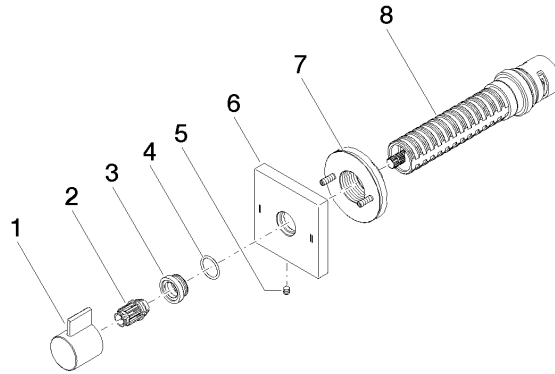

### Spare parts list

No.	Item Number	Name	Quantity used	Delivery time
1	09 20 98 002-00	handle	1	10
2	09 12 12 005 90	fixing cap	1	2
3	09 12 12 043-00	base	1	10
4	09 14 10 017 90	seal	1	2
5	09 31 11 294 90	pin	1	2
6	09 27 98 037-00	rosette	1	10
7	90 21 02 181 00 90	disc	1	2
8	90 90 03 304 10 90	diverter	1	2